

Provider Accessibility Initiative (PAI): Provider Self-Reporting Form



**arkansas
total care**

ArkansasTotalCare.com
1-866-282-6280 (TTY: 711)

Provider Accessibility Initiative (PAI): Provider Self-Reporting Form

Please fill out the criteria below and return one form for each Group Practice/Clinic/Service location where you serve members.

Provider Name	Location Address Line 1 (Street Address Only)
Provider Type	Location Address Line 2 (#, Building, Suite, Box, Department, Floor)
TIN	Location City
Provider NPI	Location State
Do you have another service location? Y/N (If yes, please fill out a separate form.) <input type="checkbox"/> Yes <input type="checkbox"/> No	Location Zip Code

Provider Disability Access Critical Elements (CEs)

Are you in compliance with all of the following minimum standards of disability access related to parking?

PARKING (P): Required number of parking spaces, including required number of van-accessible spaces, are available. Pathways have curb ramps from off-street public parking routes have curb ramps at the parking locations. Pathways from off-street public parking routes also have curb ramps at drop-off locations.

Yes No

If you checked “Yes”, you are certifying that you meet all of the 4 critical elements under parking and can proceed to the next section.
If you checked “No”, please check the boxes for the parking critical elements that are met.

Provider Accessibility Initiative (PAI): Provider Self-Reporting Form

PARKING (P) CRITICAL ELEMENTS

Please check which of the following standards are met:

Question #	Criteria (CE= Critical Elements)	Explanation/Guidelines	Yes	No	N/A	Comments
3 (CE)	<p>Are the correct number of accessible parking spaces provided?</p> <ul style="list-style-type: none"> • 1 to 25 total spaces – 1 required • 26 to 50 – 2 required • 51 to 75 – 3 required • 76 to 100 – 4 required • 101 to 150 – 5 required • 151 to 200 – 6 required • 201 to 300 – 7 required • 301 to 400 – 8 required 	<p>If there are 25 total parking spaces or less, at least one accessible space is required. If there are between 26 and 50 total spaces, at least two accessible spaces are required, etc.</p>				
7 (CE)	<p>Do curbs on any routes from off-street public parking have curb ramps at the parking locations?</p>	<p>Pathways should have curb ramps. Without curb ramps, wheelchair users may be required to travel in the street or behind parked cars where drivers cannot see them.</p>				
8 (CE)	<p>Do curbs on any routes from off-street public parking have curb ramps at the drop off locations?</p>	<p>See Question #7, above.</p>				
11 (CE)	<p>Is van accessible parking provided?</p>	<p>1 van space for every 6 standard accessible spaces must be provided, but never less than one. For example, if there are 23 total spaces, at least one accessible space is required and it must be large enough (See Question # 5 for dimensions) to accommodate a van. If there are 201 total parking spaces, at least seven accessible spaces would be required and two of those would have to accommodate vans.</p>				

Provider Accessibility Initiative (PAI): Provider Self-Reporting Form

Are you in compliance with all of the following minimum standards of disability access related to exterior building?
 EXTERIOR BUILDING (EB): There is an accessible ramp to the building. Curb ramps and other ramps to the building are wide enough for a wheelchair/scooter. Handrails are provided on both sides of the ramp. Doors are wide enough to allow entrance for a wheelchair/scooter and the doors have handles that are easily opened.

Yes No

If you checked “Yes”, you are certifying that you meet all of the 9 critical elements under exterior building and can proceed to the next section.
 If you checked “No”, please check the boxes for the exterior building critical elements that are met.

EXTERIOR BUILDING (EB) CRITICAL ELEMENTS



Please check which of the following standards are met:

EXTERIOR BUILDING ROUTE TO TRAVEL (EBRT): Outside accessible routes exist from parking, public transportation, and sidewalks.

Question #	Criteria (CE= Critical Elements)	Explanation/Guidelines	Yes	No	N/A	Comments
16 (CE)	For exterior routes, if the accessible route crosses a curb, is a curb ramp provided to the building entrance from the following areas? (Mark N/A for those that do not apply.)	Survey each exterior route when there are multiple main entrances				
16a (CE)	Parking					
16b (CE)	Public transportation					
16c (CE)	Sidewalk					

Provider Accessibility Initiative (PAI): Provider Self-Reporting Form

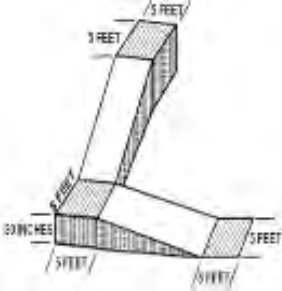
RAMPS (RA): Ramps along travel routes have the required run, handrails, and width.

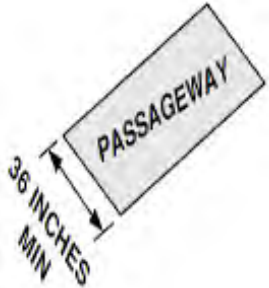
Question #	Criteria (CE= Critical Elements)	Explanation/Guidelines	Yes	No	N/A	Comments
22 (CE)	Is each run (leg) of the ramp no longer than 30 feet between landings?	<p>Each “run,” shown in the white sections in the diagram below, must be no longer than 30 feet.</p> 				
24 (CE)	Are handrails provided on both sides of the ramp that are mounted between 34 and 38 inches above the ramp surface, if it is longer than 6 feet?	<p>If the ramp is not longer than 6 feet, check N/A.</p> 				
25 (CE)	Are all ramps at least 36 inches wide?					

Provider Accessibility Initiative (PAI): Provider Self-Reporting Form

BUILDING ENTRANCE (BE): When main entrances are not accessible, clear directional signage shows the locations of the accessible entrance(s). This includes door(s): approach, openings, and handles.

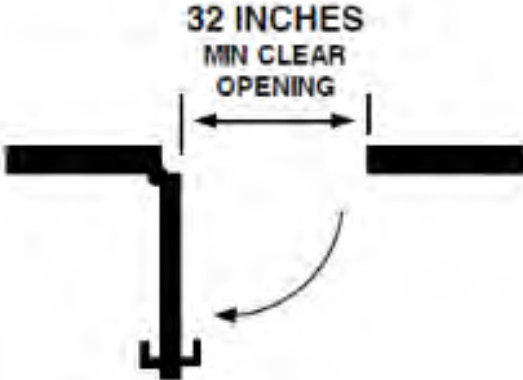
Question #	Criteria (CE= Critical Elements)	Explanation/Guidelines	Yes	No	N/A	Comments
27 (CE)	If the main entrance(s) are not accessible, are there other accessible entrances?					
28 (CE)	If the main entrances are not accessible, are there directional signage indicating the location of the accessible entrances?					
29 (CE)	Do doors have an opening at least 32 inches wide (at the narrowest point below the opening hardware) when opened to 90°?	<p>When measuring double doors, measure the opening with one door open to 90°.</p> 				
30 (CE)	Is space available for a wheelchair user to approach, maneuver, and open the door?	<p>Appropriate space perpendicular and parallel to a doorway permits a wheelchair user, people using walkers and other mobility devices to open the door safely and independently. Following are two common examples of required minimum maneuvering clearances:</p> <ol style="list-style-type: none"> 1. Approaching the door and pulling it toward you to open requires 60 inches of clear space perpendicular to the doorway and 18 inches parallel to the doorway. 				

Provider Accessibility Initiative (PAI): Provider Self-Reporting Form

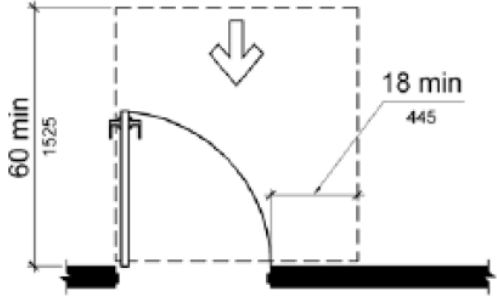
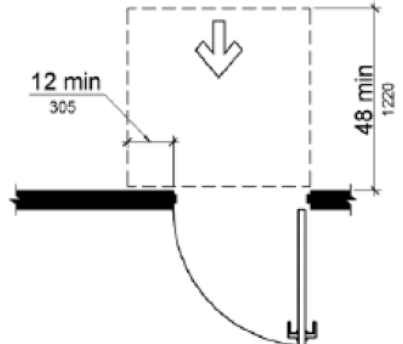
		<p>2. Approaching the door and pushing it away from you to open requires 48 inches of clear space perpendicular to the doorway.</p>  <p style="text-align: center;">(a) front approach, pull side</p>  <p style="text-align: center;">(c) front approach, push side, door provided with both closer and latch</p>			
33 (CE)	Do entrance doors have handles that can be opened without grasping, pinching, or twisting of the wrist?	Can the door be opened by someone with a closed fist or fully open hand? Door knobs, for example, cannot be used in this manner.			

Provider Accessibility Initiative (PAI): Provider Self-Reporting Form

The chart that follows details the four CE's of minimum standards of disability access related to parking. Are you in compliance with all of the following minimum standards of disability access related to interior building?

INTERIOR BUILDING (IB): Doors are wide enough for a wheelchair/scooter and have handles that are easily opened. There are interior ramps available and the ramps have handrails. If an elevator is present, it must be available for use by the public and members. The elevator has easy-to-hear sounds and Braille buttons within reach. The elevator is large enough for a wheelchair/scooter to turn around. The restroom is accessible, has doors wide enough to accommodate a wheelchair/scooter and are easy to open. Offices have height adjustable exam table(s), and adequate, clear floor space inside the area where the equipment is for side transfers by wheelchair or scooter users. When needed there is availability of lift equipment. If a chair lift is present, it can be utilized without help.

Yes No

If you checked "Yes", you are certifying that you meet all of the 29 critical elements under interior building and can proceed to the next section.

If you checked "No", please check the boxes for the interior building critical elements that are met.

INTERIOR BUILDING (IB) CRITICAL ELEMENTS

Please check which of the following standards are met:

ROUTE TO TRAVEL (IBRT): Accessible routes include wide paths. There are stairs that have handrails on each side. There are platform lifts that are usable without assistance. (From the building entrance to the clinic/office entrance, to the registration counter/window, and through the clinic/office to area)

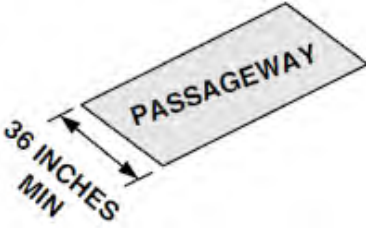
Question #	Criteria (CE= Critical Elements)	Explanation/Guidelines	Yes	No	N/A	Comments
36 (CE)	Are all interior paths of travel at least 36 inches wide?					
39 (CE)	If there are stairs on the accessible route, are there handrails on each side?	If there are no stairs, check N/A.				
42 (CE)	If a platform lift is used, can it be used without assistance?	If there is no platform lift, check N/A. Lifts sometimes require a key for operation, thus preventing independent use.				

Provider Accessibility Initiative (PAI): Provider Self-Reporting Form

ELEVATORS (E): Elevators in multi-story buildings are available to the public, accommodate wheelchair and scooter users, and have essential features including but not limited to: visible signals, audible door opening/closing signals, floor indicators, raised letter and Braille signage, reachable call buttons.

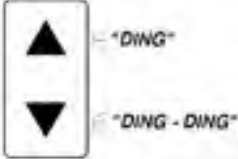
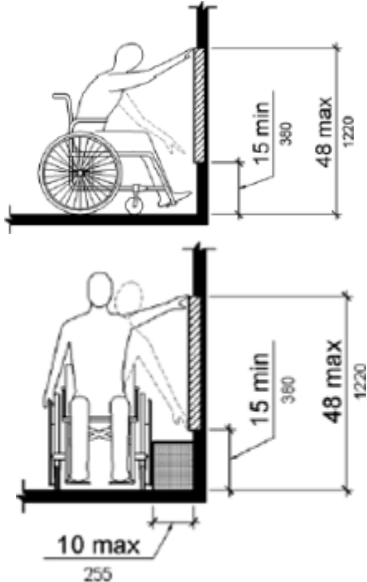
Question #	Criteria (CE= Critical Elements)	Explanation/Guidelines	Yes	No	N/A	Comments
55 (CE)	Is the elevator available for public use during business hours?					
56 (CE)	Is the elevator equipped with both visible and audible door opening/closing and floor indicators?	<p>A visible and audible signal is required at each elevator entrance to indicate which car is answering a call. An audible signal would be a “ding” or a verbal announcement.</p> 				
57 (CE)	Is there a raised letter and Braille sign on each side of each elevator jamb?	These signs allow everyone to know which floor they are on before entering or exiting the elevator.				
58 (CE)	Are the hall call buttons for the elevator no higher than 48 inches from the floor?					

Provider Accessibility Initiative (PAI): Provider Self-Reporting Form

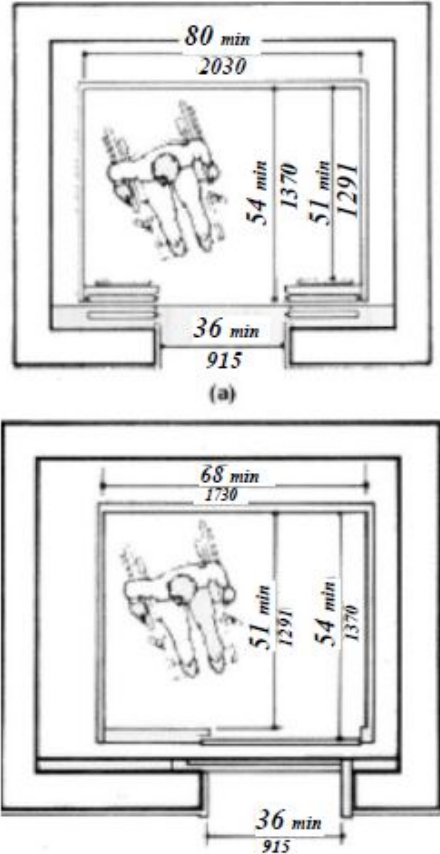
<p>59 (CE)</p>	<p>Is the elevator car large enough for a wheelchair or scooter user to enter, turn to reach the controls, and exit?</p>	<p>The doorway should be at least 36 inches wide and the floor area should be at least 51 inches long and 80 inches wide or 54 inches long and 68 inches wide, depending on where the door is located.</p>  <p style="text-align: center;">(a)</p>				
<p>60 (CE)</p>	<p>Do the buttons on the control panel inside the elevator have Braille and raised characters/symbols near the buttons?</p>					

Provider Accessibility Initiative (PAI): Provider Self-Reporting Form

RESTROOM (R): The restroom is accessible, has doors wide enough to accommodate a wheelchair/scooter and are easy to open. The restroom is large enough for a wheelchair/scooter to turn around and close the door. The restroom has grab rails which allows a transfer from the wheelchair to the toilet. Toilet paper is easy to reach. The sink is accessible and the faucets and soap are easy to reach and use. (Including those used for specimen collection)

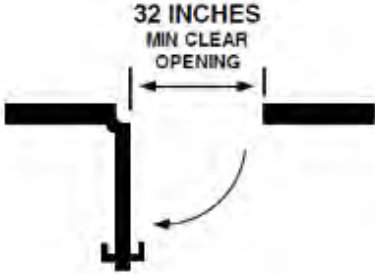
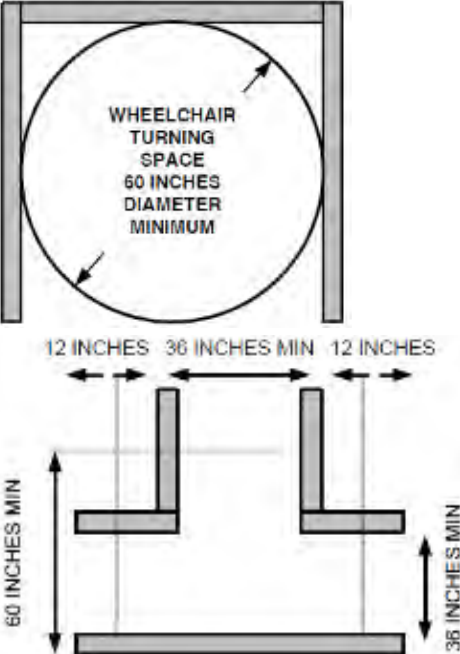
Question #	Criteria (CE= Critical Elements)	Explanation/Guidelines	Yes	No	N/A	Comments
67 (CE)	Do toilet room doorways have a minimum clear opening of 32 inches with the door open at 90 degrees, measured between the face of the door and the opposite stop?	<p>If there is no toilet room without stalls, check N/A.</p>  <p>The diagram illustrates a door opening at a 90-degree angle. A horizontal double-headed arrow indicates the clear opening, labeled "32 INCHES MIN CLEAR OPENING". A curved arrow shows the door's path from the closed position to the open position.</p>				
69 (CE)	Is there a 60-inch diameter turning circle or a 60 inch x 60 inch "T"-shaped space inside the toilet room and stalls to allow a turnaround for wheelchair and scooter users?	<p>If there is no toilet room with stalls, check N/A.</p>  <p>The diagram shows a top-down view of a "T"-shaped clear space. A circle with a diameter of 60 inches is inscribed within the horizontal bar of the "T", labeled "WHEELCHAIR TURNING SPACE 60 INCHES DIAMETER MINIMUM". The horizontal bar is 36 inches wide, with 12 inches of clear space on each side of the central 36-inch section. The vertical stem of the "T" is 60 inches long, with 36 inches of clear space at its base. The diagram is labeled with "12 INCHES", "36 INCHES MIN", "12 INCHES", "60 INCHES MIN", and "36 INCHES MIN".</p>				

Provider Accessibility Initiative (PAI): Provider Self-Reporting Form

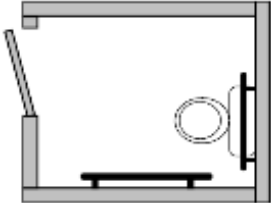
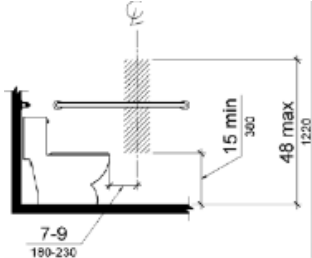
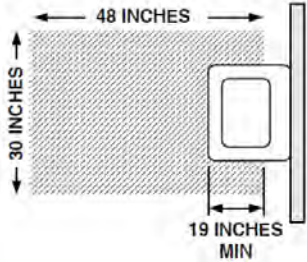
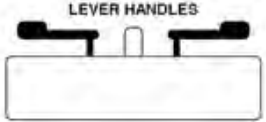
70 (CE)	<p>For all toilet rooms with and without stalls:</p> <p>Are grab bars provided, one on the wall behind the toilet and one on the wall next to the toilet?</p>	<p>Grab bars should be installed in a horizontal position between 33 and 36 inches above the floor measured to the top of the gripping surface.</p> 				
72 (CE)	<p>Is the toilet paper dispenser mounted below the side grab bar with the centerline of the toilet paper dispenser between 7 inches and 9 inches in front of the toilet, and at least 15 inches high?</p>					
73 (CE)	<p>Is there a space that is at least 30 inches wide and 48 inches deep to allow wheelchair users to park in front of the sink?</p>	<p>This space must extend at least 17 inches under the sink from the front edge, although it can extend up to 19 inches underneath.</p> 				
76 (CE)	<p>Are faucet handles operable with one hand and without grasping, pinching, or twisting?</p>	<p>Check Yes if faucets are automatic. A knob handle would not be accessible.</p> 				

Provider Accessibility Initiative (PAI): Provider Self-Reporting Form

EXAM/TREATMENT AREAS (E): There is an accessible route to and through the exam room; an entry door with adequate clear width, maneuvering clearance, and accessible hardware; appropriate placement of accessible examination equipment; and adequate clear floor space inside the room for side transfers and use of lift equipment.

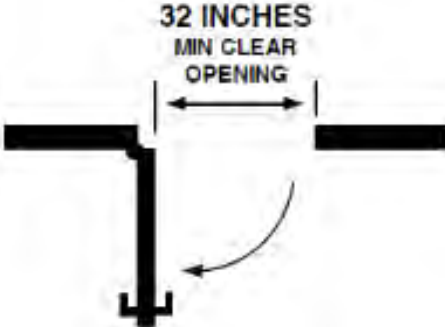
Question #	Criteria (CE= Critical Elements)	Explanation/Guidelines	Yes	No	N/A	Comments
82 (CE)	Do exam/treatment rooms, doorways, and other entrances and exits have a minimum clear opening of 32 inches with the door open at 90 degrees, measured between the face of the door and the opposite stop?	 <p style="text-align: center;">32 INCHES MIN CLEAR OPENING</p>				

EXAM TABLES (T): Offices have height adjustable exam table(s), and adequate, clear floor space inside the area where the equipment is for side transfers by wheelchair or scooter users. When needed there is availability of lift equipment.

Question #	Criteria (CE= Critical Elements)	Explanation/Guidelines	Yes	No	N/A	Comments
83 (CE)	Is there a height adjustable exam table that lowers to between 17 inches and 19 inches from the floor to the top of the cushion?					

Provider Accessibility Initiative (PAI): Provider Self-Reporting Form

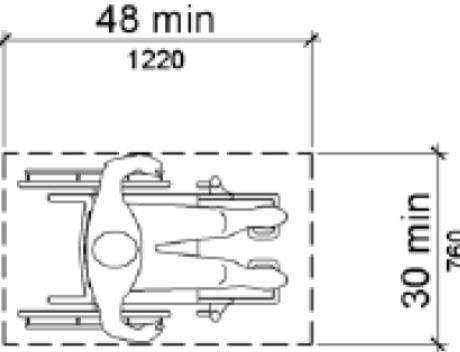
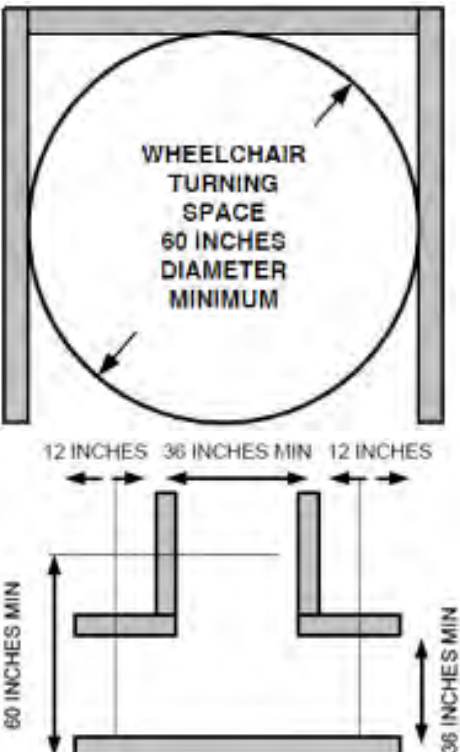
84 (CE)	Is there space next to the height adjustable exam table for a wheelchair or scooter user to approach, park, and transfer or be assisted to transfer onto the table?					
86 (CE)	Is lift equipment available to assist with transfers (portable, overhead, or ceiling mounted)?					
87 (CE)	Are staff trained at least yearly on safe transfer techniques?					
88 (CE)	Is there a 60 inch diameter turning circle or a 60 inch x 60 inch "T"-shaped space so that a wheelchair or scooter user can make a 180° turn?					

Provider Accessibility Initiative (PAI): Provider Self-Reporting Form

SCALES (S): Accessible scales are available for wheelchair and scooter users and for those who have difficulty or who are unable to step up onto a standard scale.

Question #	Criteria (CE= Critical Elements)	Explanation/Guidelines	Yes	No	N/A	Comments
89 (CE)	Is a weight scale available in the office with a platform to accommodate a person sitting in a wheelchair or scooter?	Accessible scales are usable by all people including: wheelchair users, people with activity limitations, and larger people who may exceed a standard weight scale limit. This includes people with conditions that interfere with mobility, walking, climbing, using steps (joint pain, short stature, pregnancy, fatigue, respiratory and cardiac conditions, post-surgical conditions, orthopedic injuries); and/or who use mobility devices (e.g. canes, crutches, walkers).				

COMMON AREA (CA): Members can get to and use all common areas and equipment with or without help. (Activity room, therapy room, waiting room, etc.)

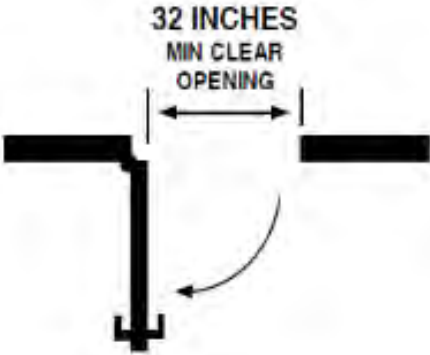
Question #	Criteria (CE= Critical Elements)	Explanation/Guidelines	Yes	No	N/A	Comments
90 (CE)	Do doorways have a minimum clear opening of 32 inches with the door open at 90 degrees, measured between the face of the door and the opposite stop?	 <p>The diagram illustrates a door frame with the door swung open at a 90-degree angle. A horizontal double-headed arrow indicates the clear opening between the door's face and the opposite stop, labeled '32 INCHES MIN CLEAR OPENING'. A curved arrow points to the door's edge, indicating the 90-degree opening.</p>				

Provider Accessibility Initiative (PAI): Provider Self-Reporting Form

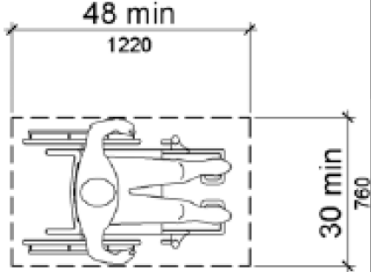
91 (CE)	Is there space in the following areas for a wheelchair or scooter user to approach and park for participation in activities or use of exercise equipment?					
91a (CE)	Quiet room					
91b (CE)	Physical Therapy Room					
91c (CE)	Occupational Therapy					
91d (CE)	Activity Area					

DIAGNOSTIC AREAS (DA): Patients are able to access and use testing and treatment areas, and equipment.

Question #	Criteria (CE= Critical Elements)	Explanation/Guidelines	Yes	No	N/A	Comments
96 (CE)	Is there height adjustable equipment (chairs and tables) that lower between 17 inches and 19 inches from the floor to the top of the cushion? Equipment is including, but not limited to:	Evaluate whether each piece of equipment does or does not lower 17 to 19 inches from the floor to the top of the cushion:				
96a (CE)	MRI					
96b (CE)	CT					
96c (CE)	Fluoroscopy					
96d (CE)	PET					
96e (CE)	Bone Density/DEXA scan					
96f (CE)	Ultrasound					
96g (CE)	Nuclear Medicine					
96h (CE)	X-ray					
96i (CE)	Physical Therapy Table					

Provider Accessibility Initiative (PAI): Provider Self-Reporting Form

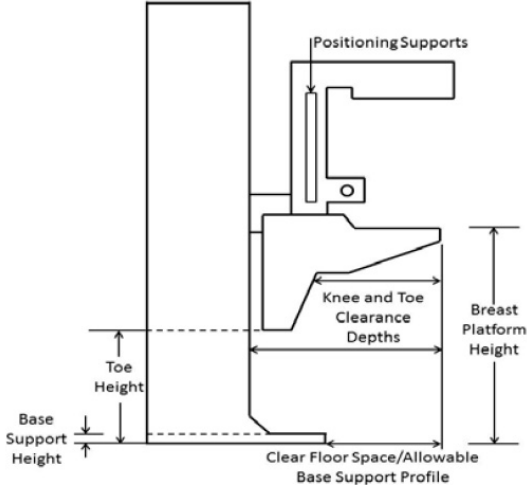
96j (CE)	Dialysis Chair					
96k (CE)	Other					
96l (CE)	Other					
97 (CE)	Can the mammography machine accommodate wheelchair users with knee and foot clearance under the breast plate?	<p>The top of breast platform needs to go to 26 inches above the floor to accommodate an individual seated in a wheelchair.</p> 				
98 (CE)	Is a mammography chair available for members who must be seated? Examples include persons with balance difficulties, or who cannot stand for any length of time.	The chair's footrests must accommodate and ride over the base support.				
100 (CE)	Are staff trained to accurately answer questions regarding accessibility of medical and diagnostic equipment?					
101 (CE)	Does staff provide transfer assistance on and off of equipment (this includes use of lift equipment when needed)?					

Provider Accessibility Initiative (PAI): Provider Self-Reporting Form

Are you in compliance with all of the following minimum standards of disability access related to programmatic access?

PROGRAMMATIC ACCESS (PA): Programmatic access includes, but is not limited to: methods of communicating with member for the provision of individual medical information and general health information; appointment scheduling procedures and time slots; and system-wide coordination and flexibility to enable access.

Yes No

If you checked “Yes”, you are certifying that you meet all of the 8 critical elements under programmatic access and can proceed to the next section.

If you checked “No”, please check the boxes for the programmatic access critical elements that are met.

PROGRAMMATIC ACCESS (PA) CRITICAL ELEMENTS

Please check which of the following standards are met:

MATERIALS IN ALTERNATIVE FORMATS (MA): Available upon request in formats including but not limited to Braille, Audio recordings, Large print, pictures, electronic text and by in-person staff assistance.

Question #	Criteria (CE= Critical Elements)	Explanation/Guidelines	Yes	No	N/A	Comments
102 (CE)	Are print and other media (e.g. web, and app-based) materials in alternative formats available upon request and is someone designated to provide them? Alternative formats includes but is not limited to: Braille, audio recordings, large print, pictorial based, and electronic text	Use of large print forms, electronic or online web-based forms, or in-person staff assistance in a private location.				

Provider Accessibility Initiative (PAI): Provider Self-Reporting Form

COMMUNICATION ACCESS (CA): Available on request and includes but is not limited to: Sign Language interpreters, Oral interpreters, Letter/word/picture/translator boards, Assistive listening devices, Computer assisted real-time transcription, Video remote interpretation, longer appointments, etc.

Question #	Criteria (CE= Critical Elements)	Explanation/Guidelines	Yes	No	N/A	Comments
103 (CE)	Are there policies and procedures in place that describe how and who is responsible for providing accessible communication in a timely manner? Do those policies and procedures include a description of how members can access the following: qualified or certified American Sign Language interpreters, oral interpreters, letter/word/picture/translator boards, assistive listening devices, computer assisted real-time transcriptions, video remote interpretation, and other					

DISABILITY-SPECIFIC ACCESS): Examples include avoiding waiting in a reception area, accommodating service animal users, etc.

Question #	Criteria (CE= Critical Elements)	Explanation/Guidelines	Yes	No	N/A	Comments
106 (CE)	Do you have a process for people with disabilities who cannot tolerate waiting in a reception area to be seen immediately upon arrival?	For example, some people with cognitive, intellectual or mental health disabilities may be unable to wait in a crowded reception area without becoming agitated or anxious.				
108 (CE)	Do you allow service animals to accompany individuals in waiting rooms, examination rooms, and all other areas?	People with service animals expect the animal to accompany them into the waiting and examination rooms, and this is a protected right under the Americans with Disabilities Act. A policy enables offices to be prepared to respond appropriately to the needs of everyone.				

Provider Accessibility Initiative (PAI): Provider Self-Reporting Form

SCHEDULING ASSISTANCE (SA): Accessibility and accommodation needs of all individuals including when making referrals to and scheduling follow-up appointments with specialists, labs, and other health care services.

Question #	Criteria (CE= Critical Elements)	Explanation/Guidelines	Yes	No	N/A	Comments
113 (CE)	Is there a referral process in place that attends to accessibility and accommodation needs when making referrals to and scheduling follow-up appointments with specialists, labs, and ancillary services?	People with disabilities may be unable to comply with medical recommendations if referred to a location of testing, special treatment or a specialist that is not accessible or is not prepared to provide the recommended service.				
114 (CE)	When scheduling appointments, are all members always asked to identify or reconfirm assistance and accommodation needs, they or someone coming with them might have (regardless of an apparent or hidden disability)?	For example, are members asked, "Will you or someone coming with you need any assistance with filling out forms, communicating, speaking, getting on and off an exam table, walking, seeing, reading, or hearing during your appointment?"				
115 (CE)	When scheduling appointments, are assistance or accommodation needs documented in the Electronic Health Record (EHR) or paper health record?					

By my signature below, I attest that to the best of my knowledge, the accessibility information provided on this form is an accurate reflection of the disability access at this location.

Signature: _____

Date: _____